



Monaco 1035

Industrial Femtosecond Laser

Monaco 1035 is an industrial femtosecond laser with a MOPA architecture. Designed for high-uptime in 24/7 applications, the laser family provides $>80 \mu\text{J}/\text{pulse}$ at 1035 nm. Standard repetition rates up to 50 MHz at 60 W enable current and future throughput requirements in materials processing and microelectronics applications. Homogeneous materials such as glass and metals, as well as complex, layered structures for the FPD and mobile markets are readily addressed with Monaco's sub-350 fs pulsewidth. Additionally, on-the-fly tuning enables variable pulsewidths to $>10 \text{ ps}$.



FEATURES & BENEFITS

- $80 \mu\text{J}/\text{pulse}$ for processing of high ablation threshold materials
- 60 W average power for high throughput
- $<350 \text{ fs}$ standard pulsewidth for low HAZ machining
- Variable pulsewidth from $<350 \text{ fs}$ to $>10 \text{ ps}$ for process tailoring
- Repetition rate to 50 MHz for fast processing with polygon scanners
- $>320 \mu\text{J}$ seeder burst mode for glass processing
- Compact single box design for ease of integration
- HALT-designed and HASS-verified to ensure quality and reliability

APPLICATIONS

- Glass Cutting and Welding
- Thin Film/Foil Cutting
- IC Package Cutting
- Medical Device Manufacturing
- OPA Pumping for Optogenetics



OPTICAL SPECIFICATIONS ¹	Monaco 1035-40-40	Monaco 1035-80-60
Fundamental Center Wavelength (nm)	1035 ±5	1035 ±5
Output Power (W)	40	60
Energy (μJ)	40 (at 1 MHz)	80 (at 750 kHz)
Seeder Burst Mode (μJ)	>200	>320
Repetition Rate	Single-shot to 1 MHz, higher rep. rates without AOM pulsepicking: 1 to 50 MHz standard	
Pulsewidth (fs)	<350	
Tuning Range	<350 fs to >10 ps	
Spatial Mode	TEM ₀₀ , M ² <1.2	
Beam Divergence (mrad, 2θ)	<1	
Beam Diameter at Output ² (mm, 1/e ²)	2.7 ±0.3	
Beam Circularity (%)	>85	
Polarization Ratio	>100:1	
Polarization Direction ³	Vertical ±3°	
Beam Pointing Stability (μrad/°C)	<25	
Pulse Energy Stability (%) (RMS)	<1.5	
Power Stability (%) (RMS, 2σ)	<1.5	
Warm-up Time (minutes)		
Cold Start	<45	
Warm Start	<15	
Long-term Pointing Stability (μrad)	±25 over 8 hours	
Head Weight	50 kg (110 lbs.)	
External Comms	RS-232, Ethernet, USB	
Power Consumption ⁴ (typical)	48VDC, <500W	
OPERATING SPECIFICATIONS		
Temperature (non-condensing)		
Laser Head	+10 to 30°C (50 to 86°F)	
Power Supply	-20 to +60°C (-4 to 140°F)	
Non-Operation (storage)	5 to 65°C (41 to 149°F)	
Relative Humidity (%)	<90, non-condensing	
SHIPPING SPECIFICATIONS		
Temperature	-20 to +60°C (-4 to 140°F)	

1 All specifications at maximum energy.
2 Measured at 1m from laser output window.
3 External isolation required depending on application.
4 Optional 110 to 240VAC power supply available.

TYPICAL PERFORMANCE DATA

Monaco 1035 Sample Spatial Mode at 1 MHz

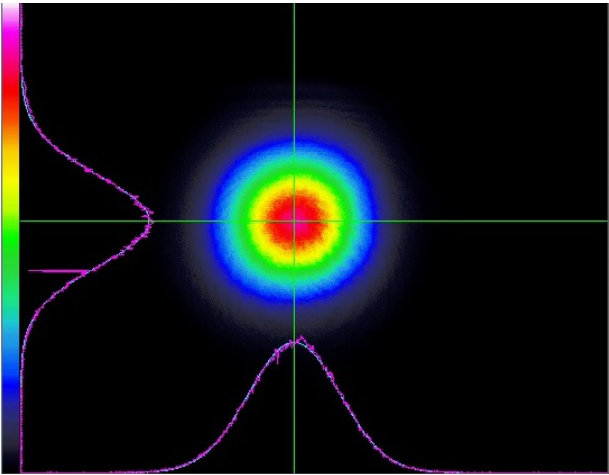

Monaco 1035 Energy/Pulse vs. Repetition Rate

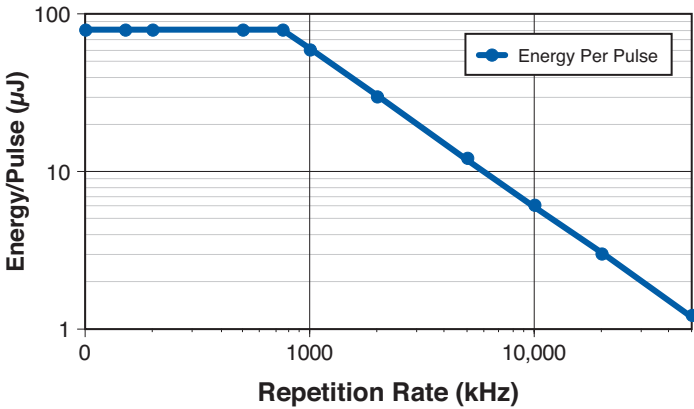

Monaco 1035 Sub-350 fs Temporal Profile (Autocorrelator)

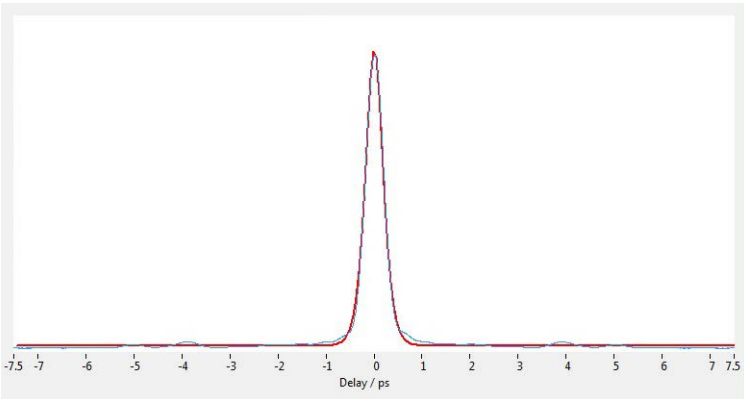

MECHANICAL SPECIFICATIONS

Monaco 1035 Power Supply

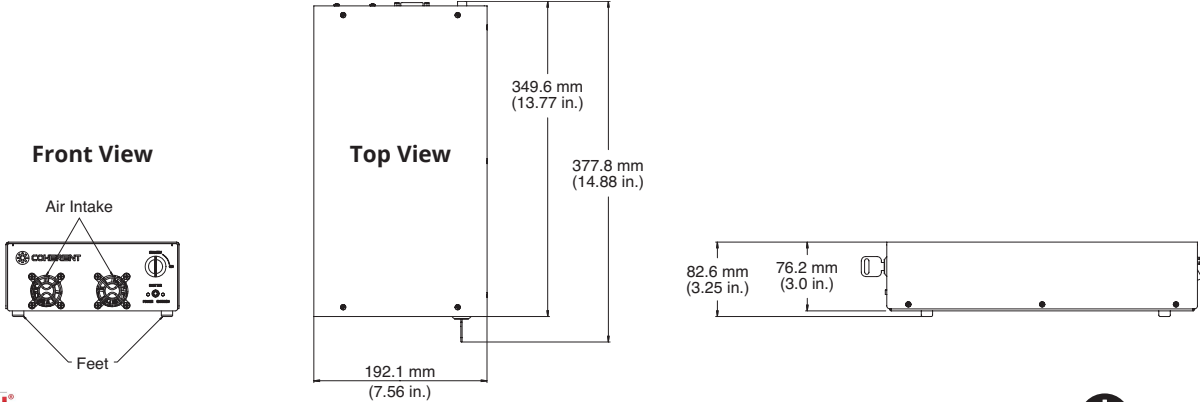

MECHANICAL SPECIFICATIONS

Monaco 1035

Front View

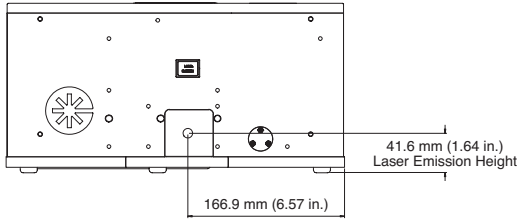

Rear View

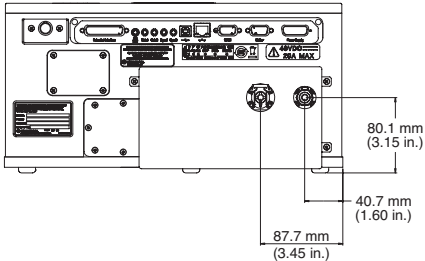

Side View

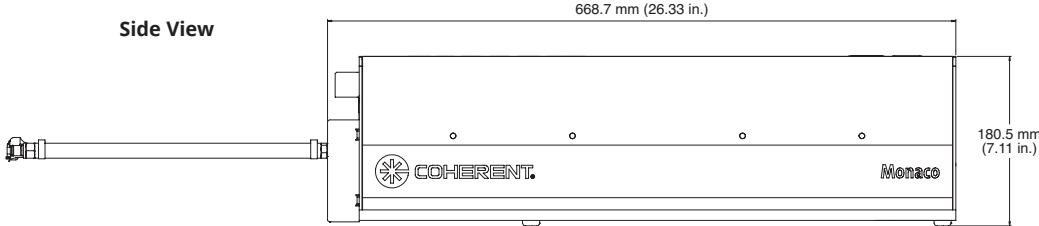

Top View

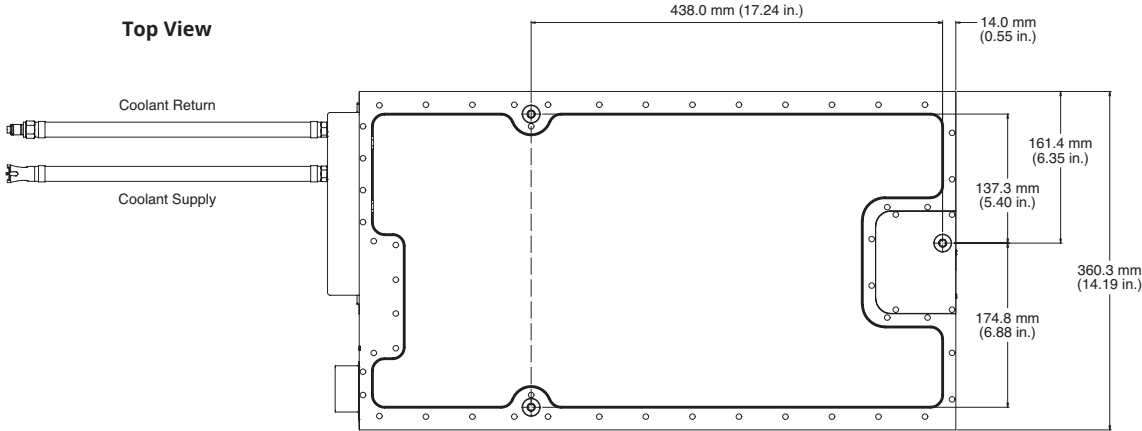

Coherent, Inc.,
 5100 Patrick Henry Drive Santa Clara, CA 95054
 p. (800) 527-3786 | (408) 764-4983
 f. (408) 764-4646

tech.sales@coherent.com www.coherent.com



NAMSON TECHNOLOGY - ENGINEERING CO., LTD

Address : 51-53 Pho Quang Street, Ward 2, Tan Binh
 District, Ho Chi Minh city, Vietnam
 Hotline: 0909 961 715
 Tel: (028) 3997 442

www.namson.com.vn



Coherent follows a policy of continuous product improvement. Specifications are subject to change without notice. Coherent's scientific and industrial lasers are certified to comply with the Federal Regulations (21 CFR Subchapter J) as administered by the Center for Devices and Radiological Health on all systems ordered for shipment after August 2, 1976.

Coherent offers a limited warranty for all Monaco 1035 Lasers. For full details of this warranty coverage, please refer to the Service section at www.coherent.com or contact your local Sales or Service Representative. MC-005-18-0M0120Rev.A Copyright ©2020 Coherent, Inc.

